

FM2 - FM3 LEVER HANDLE

FM4 ADVANTAGES

MERCHANDISE DISPLAY

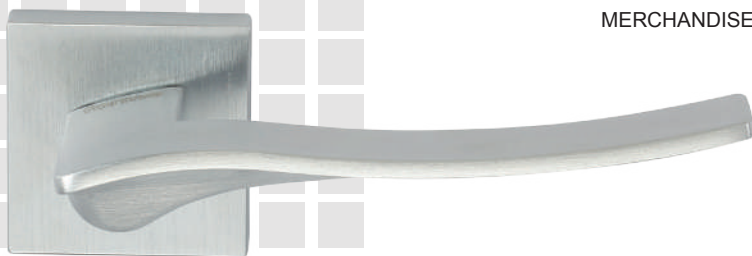



A184/ALICE/SC

U/Price: 460.00

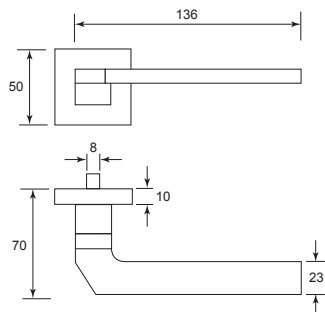

A185/PAOLA/SC

U/Price: 460.00

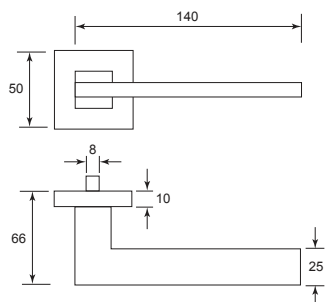

A201/VANESSA/SC

U/Price: 460.00

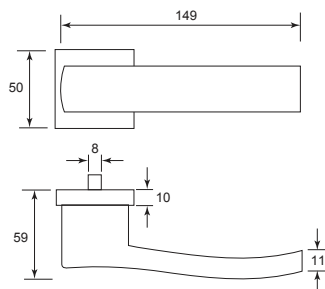

LEVER HANDLE



A280/OLIMPIA/SC

U/Price: 460.00

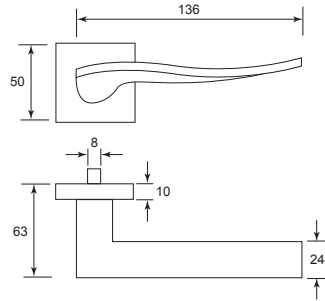

A422/BOSTON/SC

U/Price: 460.00

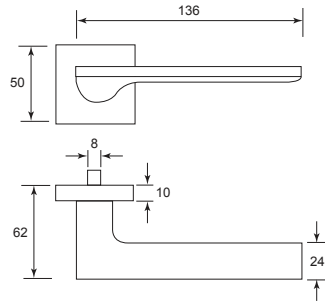

A508/MERGELLINA/SC

U/Price: 460.00

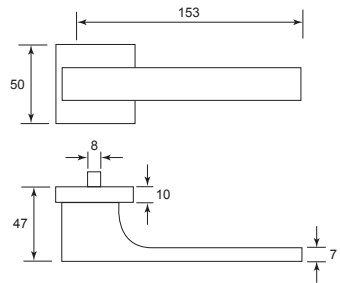

Merchandise Stand & Advantages



**Quality Handles
Made In Italy**



**Made With High Quality
Zamak Alloy Material**



**Ecotech® Environmentally
Friendly Technology**



**High Abrasion / Chemical
Resistance**