

Kaadas

Access to your Future !

Lamborghini
THE
LEGEND















PUSH & PULL LOCK

KX



3D
FACE RECOGNITION



-  Lithium Rechargeable Battery
-  100 Fingerprint User
-  100 Card User
-  20 Face Recognition
-  10 Password User
-  Mechanical Key Provided
-  Voice Guide (English & Chinese)
-  Emergency Power Supply (Micro USB)
-  High Security EN Mortise
-  Auto Locking Function
-  Double Authentication
-  Fake Pin Code
-  Defense Mode
-  Touch Screen Unlock System
-  Double Locking

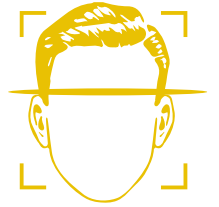

PUSH & PULL LOCK

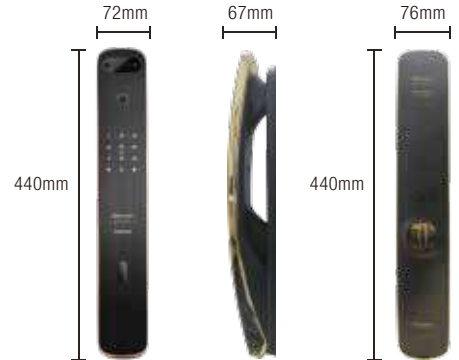
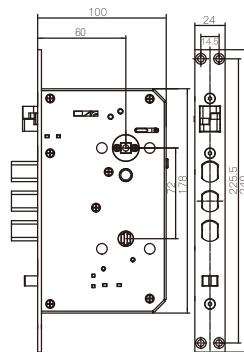

■ Product Dimension	: 440mm*72mm*67mm		
■ Finishing	: Gold & Black		
■ Material	: Zinc Alloy		
	: Card Type: Mifare1, S50 Encrypted (Kaadas Exclusive)		
	: Fingerprint Sensor: Semiconductor (Sweden FPC Fingerprint Sensor)		
	: Keypad Type: Touchpad		
■ Lock Type	: EN Stainless Steel Mortise Lock (Hole to Hole: 72mm, Backset: 60mm & 70mm)		
■ Cylinder Type	: Super Grade B		
■ Authentication	: Pin Number: 6-12 digit		
	: No of Master Pin Code: 1 user only		
	: No of Pin Code Registration: Up to 10 users		
	: No of RFID Card Registration: Up to 100 users		
	: No of Fingerprint Registration: Up to 100 users		
	: No of Mechanical Key Combination: 2 keys		
	: No of Face Recognition: 20 Users		
■ Installation	: Door Thickness: 35- 60mm (Default), 60-90mm (Optional)		
	: Door Opening Direction: Universal Direction		
	: Door Type: Wooden Door, Security Door & others		
■ Power Supply	: Battery: Lithium Rechargeable Battery		
	: Working Voltage: DC 6V		
	: Battery Life: Rechargeable (Micro USB)		
	: Emergency Power Supply: 5V Micro USB Power Bank		
■ Included Accessories	:		
	No	Item Name	Quantity
	1	Outside Escutcheon	1
	2	Inside Escutcheon	1
	3	EN Mortise	1
	4	Screw Pack	1
	5	User Manual	1
	6	Warranty Card	1
	7	Mechanical Keys	2
	8	Strike Plate and Dust Cover	1
	9	Installation Template	1
	10	Inside Mounting Plate	1
	11	RFID Card	2
	12	Network Module	1
			(Optional)

Kaadas















Access to your Future !

Lamborghini
LEGEND



PUSH & PULL LOCK



-  100 Fingerprint User
-  100 Card User
-  10 Password User
-  Mechanical Key Provided
-  Voice Guide (English & Chinese)
-  Emergency Power Supply (Micro USB)
-  High Security EN Mortise
-  Auto Locking Function
-  Double Authentication
-  Fake Pin Code
-  Defense Mode
-  Touch Screen Unlock System
-  Double Locking
-  Door Bell



PUSH & PULL LOCK

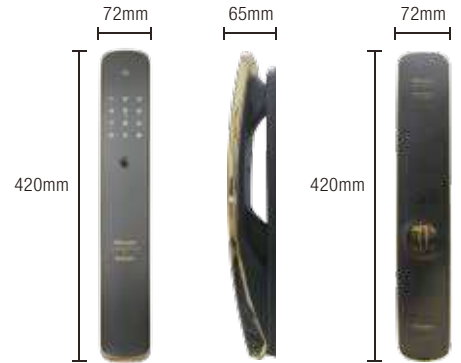
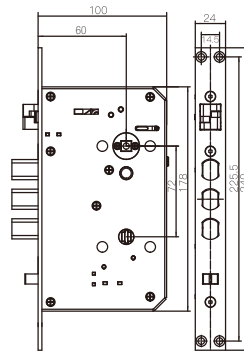

■ Product Dimension	: 420mm*72mm*65mm
■ Finishing	: Gold & Black + Red Copper & Black + Silver & Black
■ Material	: Zinc Alloy : Card Type: Mifare1, S50 Encrypted (Kaadas Exclusive) : Fingerprint Sensor: Semiconductor (Sweden FPC Fingerprint Sensor) : Keypad Type: Touchpad
■ Lock Type	: EN Stainless Steel Mortise Lock (Hole to Hole: 72mm, Backset: 60mm & 70mm)
■ Cylinder Type	: Super Grade B
■ Authentication	: Pin Number: 6-12 digit : No of Master Pin Code: 1 user only : No of Pin Code Registration: Up to 10 users : No of RFID Card Registration: Up to 100 users : No of Fingerprint Registration: Up to 100 users : No of Mechanical Key Combination: 2 keys
■ Installation	: Door Thickness: 35- 60mm (Default), 60-90mm (Optional) : Door Opening Direction: Universal Direction : Door Type: Wooden Door, Security Door & others
■ Power Supply	: Battery: AA Alkaline Battery : Battery Capacity: 4*AA Batteries or 8*AA Batteries : Working Voltage: DC 6V : Battery Life: 1 year* (*1 year: May be less depending on actual usage) : Emergency Power Supply: 5V Micro USB Power Bank : Low Battery Alert: YES

No	Item Name	Quantity	Remark
1	Outside Escutcheon	1	
2	Inside Escutcheon	1	
3	EN Mortise	1	
4	Screw Pack	1	
5	User Manual	1	
6	Warranty Card	1	
7	Mechanical Keys	2	
8	Strike Plate and Dust Cover	1	
9	Installation Template	1	
10	Inside Mounting Plate	1	
11	RFID Card	2	
12	Network Module	1	(Optional)

Kaadas

Access to your Future !















PUSH & PULL LOCK

K20



3D
FACE RECOGNITION



-  Lithium Rechargeable Battery
-  100 Fingerprint User
-  20 Face Recognition
-  10 Password User
-  Mechanical Key Provided
-  Voice Guide (English & Chinese)
-  Emergency Power Supply (Micro USB)
-  High Security EN Mortise
-  Auto Locking Function
-  Double Authentication
-  Fake Pin Code
-  Defense Mode
-  Touch Screen Unlock System
-  Double Locking
-  Door Bell

Kaadas

Access to your Future !

3D
FACE RECOGNITION



PUSH & PULL LOCK

K20

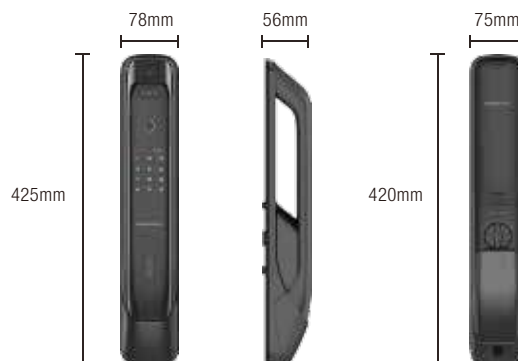
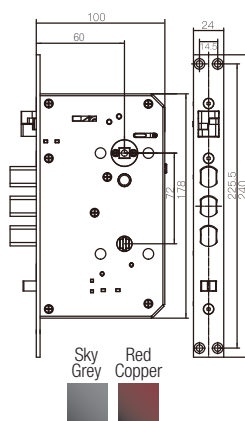

■ Product Dimension	: 425mm*78mm*56mm
■ Finishing	: Sky Grey, Sky Grey + Red Copper
■ Material	: Aluminium Alloy
	: Fingerprint Sensor : Semiconductor (Sweden FPC Fingerprint Sensor)
	: Keypad Type : Touchpad
■ Lock Type	: EN Stainless Steel Mortise Lock (Hole to Hole: 72mm, Backset: 60mm & 70mm)
■ Cylinder Type	: Super Grade B
■ Authentication	: Pin Number: 6-12 digit
	: No of Master Pin Code: 1 user only
	: No of Pin Code Registration: Up to 10 users
	: No of Fingerprint Registration: Up to 100 users
	: No of Face Recognition: 20 Users
	: No of Mechanical Key Combination: 2 keys
■ Installation	: Door Thickness: 35- 60mm (Default), 60-90mm (Optional)
	: Door Opening Direction: Universal Direction
	: Door Type: Wooden Door, Security Door & others
■ Power Supply	: Battery: Lithium Rechargeable Battery
	: Working Voltage: DC 6V
	: Battery Life: Rechargeable (Micro USB)
	: Emergency Power Supply : 5V Micro USB Power Bank

No	Item Name	Quantity	Remark
1	Outside Escutcheon	1	
2	Inside Escutcheon	1	
3	EN Mortise	1	
4	Screw Pack	1	
5	User Manual	1	
6	Warranty Card	1	
7	Mechanical Keys	2	
8	Strike Plate and Plastic Case	1	
9	Installation Template	1	
10	Inside Mounting Plate	1	
11	Network Module	1	(Optional)

Kaadas















Access to your Future !



PUSH & PULL LOCK

K10



-  100 Fingerprint User
-  100 Card User
-  10 Password User
-  Mechanical Key Provided
-  Voice Guide (English & Chinese)
-  Emergency Power Supply (Micro USB)
-  High Security EN Mortise
-  Auto Locking Function
-  Double Authentication
-  Fake Pin Code
-  Defense Mode
-  Touch Screen Unlock System
-  Double Locking
-  Door Bell

Exclusive Model

Kaadas

Access to your Future !

PUSH & PULL LOCK

K10

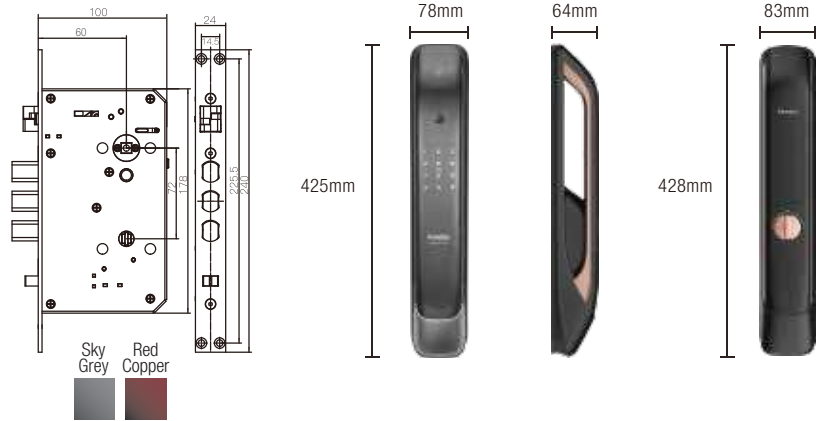

■ Product Dimension	: 425mm*78mm*64mm			
■ Finishing	: Sky Grey, Sky Grey + Red Copper			
■ Material	: Aluminium Alloy			
	: Card Type : Mifare1, S50 Encrypted (Kaadas Exclusive)			
	: Fingerprint Sensor : Semiconductor (Sweden FPC Fingerprint Sensor)			
	: Keypad Type : Touchpad			
■ Lock Type	: EN Stainless Steel Mortise Lock (Hole to Hole: 72mm, Backset: 60mm & 70mm)			
■ Cylinder Type	: Super Grade B			
■ Authentication	: Pin Number: 6-12 digit			
	: No of Master Pin Code: 1 user only			
	: No of Pin Code Registration: Up to 10 users			
	: No of RFID Card Registration: Up to 100 users			
	: No of Fingerprint Registration: Up to 100 users			
	: No of Mechanical Key Combination: 2 keys			
■ Installation	: Door Thickness: 35- 60mm (Default), 60-90mm (Optional)			
	: Door Opening Direction: Universal Direction			
	: Door Type: Wooden Door, Security Door & others			
■ Power Supply	: Battery: AA Alkaline Battery			
	: Battery Capacity: 4*AA Batteries or 8*AA Batteries			
	: Working Voltage: DC 6V			
	: Battery Life: 1 year* (*1 year: May be less depending on actual usage)			
	: Emergency Power Supply : 5V Micro USB Power Bank			
■ Included Accessories	:			
	No	Item Name	Quantity	Remark
	1	Outside Escutcheon	1	
	2	Inside Escutcheon	1	
	3	EN Mortise	1	
	4	Screw Pack	1	
	5	User Manual	1	
	6	Warranty Card	1	
	7	Mechanical Keys	2	
	8	Strike Plate and Plastic Case	1	
	9	Installation Template	1	
	10	Inside Mounting Plate	1	
	11	RFID Card	2	
	12	Network Module	1	(Optional)

Kaadas

















Access to your Future !



PUSH & PULL LOCK

KX-T



-  Bluetooth
-  100 Fingerprint User
-  100 Card User
-  10 Password User
-  Mechanical Key Provided
-  Anti-Door Viewer Attack
-  Voice Guide (English & Chinese)
-  Emergency Power Supply (Micro USB)
-  High Security EN Mortise
-  Auto Locking Function
-  Double Authentication
-  Fake Pin Code
-  Defense Mode
-  Anti Panic Function
-  Double Locking
-  Patented Mortise (Push & Pull Mechanism)

Kaadas

Access to your Future !



PUSH & PULL LOCK

K9W



- Wifi
- 100 Fingerprint User
- 100 Card User
- 20 Password User
- Mechanical Key Provided
- Voice Guide (Russian, Spanish, Portuguese, English & Chinese)
- Emergency Power Supply (Micro USB)
- High Security EN Mortise
- Auto Locking Function
- Double Authentication
- Fake Pin Code
- Defense Mode
- Touch Screen Unlock System
- Double Locking

Kaadas

Access to your Future !

PUSH & PULL LOCK

K9W

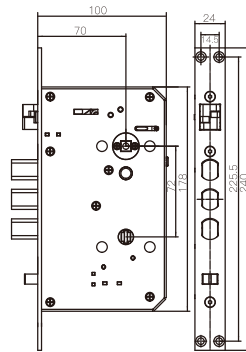

■ Product Dimension	: 400mm*85mm*70mm
■ Finishing	: Sky Grey, Red Copper
■ Material	: Aluminium Alloy
	: Card Type: Mifare1, S50 Encrypted (Kaadas Exclusive)
	: Fingerprint Sensor: Semiconductor (Sweden FPC Fingerprint Sensor)
	: Keypad Type: Touchpad
■ Lock Type	: EN Stainless Steel Mortise Lock (Hole to Hole: 72mm, Backset: 60mm & 70mm)
■ Cylinder Type	: Super Grade B
■ Authentication	: Pin Number: 6-12 digit
	: No of Master Pin Code: 1 user only
	: No of Pin Code Registration: Up to 20 users
	: No of RFID Card Registration: Up to 100 users
	: No of Fingerprint Registration: Up to 100 users
	: No of Mechanical Key Combination: 2 keys
■ Installation	: Door Thickness: 35- 60mm (Default), 60-90mm (Optional)
	: Door Opening Direction: Universal Direction
	: Door Type: Wooden Door, Security Door & others
■ Power Supply	: Battery: AA Alkaline Battery
	: Battery Capacity: 4*AA Batteries or 8*AA Batteries
	: Working Voltage: DC 6V
	: Battery Life: 1 year* (*1 year: May be less depending on actual usage)
	: Emergency Power Supply: 5V Micro USB Power Bank
	: Low Battery Alert: YES

■ Included Accessories	:			
	No	Item Name	Quantity	Remark
	1	Outside Escutcheon	1	
	2	Inside Escutcheon	1	
	3	EN Mortise	1	
	4	Screw Pack	1	
	5	User Manual	1	
	6	Warranty Card	1	
	7	Mechanical Keys	2	
	8	Strike Plate and Dust Cover	1	
	9	Installation Template	1	
	10	Inside Mounting Plate	1	
	11	RFID Card	2	

*Warranty: 2 years (*Must According to Kaadas's Terms & Conditions)

















Kaadas

Access to your Future !

PUSH & PULL LOCK

K9



-  Bluetooth
-  100 Fingerprint User
-  100 Card User
-  10 Password User
-  Mechanical Key Provided
-  Anti-Door Viewer Attack
-  Voice Guide (English & Chinese)
-  Emergency Power Supply (Micro USB)
-  High Security EN Mortise
-  Auto Locking Function
-  Double Authentication
-  Fake Pin Code
-  Defense Mode
-  Anti Panic Function
-  Double Locking
-  Patented Mortise (Push & Pull Mechanism)

Kaadas

Access to your Future !



PUSH & PULL LOCK

K9

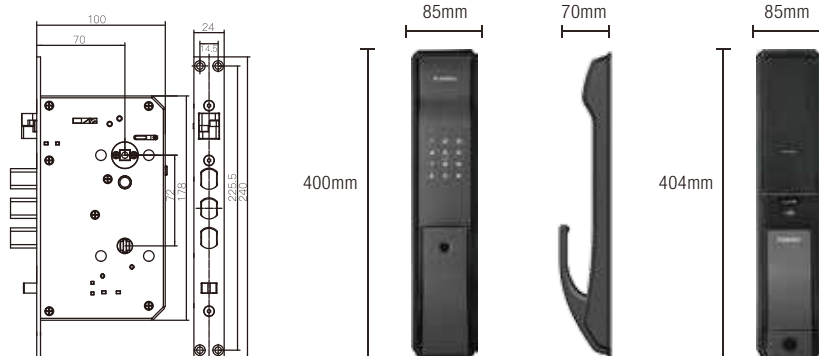

■ Product Dimension	: 400mm*85mm*70mm
■ Finishing	: Sky Grey, Red Copper
■ Material	: Aluminium Alloy
	: Card Type: Mifare1, S50 Encrypted (Kaadas Exclusive)
	: Fingerprint Sensor: Semiconductor (Sweden FPC Fingerprint Sensor)
	: Keypad Type: Touchpad
■ Lock Type	: EN Stainless Steel Mortise Lock (Hole to Hole: 72mm, Backset: 60mm & 70mm)
■ Cylinder Type	: Super Grade B
■ Authentication	: Pin Number: 6-12 digit
	: No of Master Pin Code: 1 user only
	: No of Pin Code Registration: Up to 10 users
	: No of RFID Card Registration: Up to 100 users
	: No of Fingerprint Registration: Up to 100 users
	: No of Mechanical Key Combination: 2 keys
■ Installation	: Door Thickness: 35- 60mm (Default), 60-90mm (Optional)
	: Door Opening Direction: Universal Direction
	: Door Type: Wooden Door, Security Door & others
■ Power Supply	: Battery: AA Alkaline Battery
	: Battery Capacity: 4*AA Batteries or 8*AA Batteries
	: Working Voltage: DC 6V
	: Battery Life: 1 year* (*1 year: May be less depending on actual usage)
	: Emergency Power Supply: 5V Micro USB Power Bank
	: Low Battery Alert: YES

No	Item Name	Quantity	Remark
1	Outside Escutcheon	1	
2	Inside Escutcheon	1	
3	EN Mortise	1	
4	Screw Pack	1	
5	User Manual	1	
6	Warranty Card	1	
7	Mechanical Keys	2	
8	Strike Plate and Dust Cover	1	
9	Installation Template	1	
10	Inside Mounting Plate	1	
11	RFID Card	2	

*Warranty: 2 years (*Must According to Kaadas's Terms & Conditions)

















Kaadas

Access to your Future !

PUSH & PULL LOCK

K8



-  Bluetooth (Optional)
-  100 Fingerprint User
-  100 Card User
-  10 Password User
-  Mechanical Key Provided
-  Anti-Door Viewer Attack
-  Voice Guide (English & Chinese)
-  Emergency Power Supply (Micro USB)
-  High Security EN Mortise
-  Sound Volume Adjustable
-  Auto Locking Function
-  Double Authentication
-  Fake Pin Code
-  Defense Mode
-  Anti Panic Function
-  Double Locking
-  Patented Mortise (Push & Pull Mechanism)

Kaadas

Access to your Future !



PUSH & PULL LOCK

K8

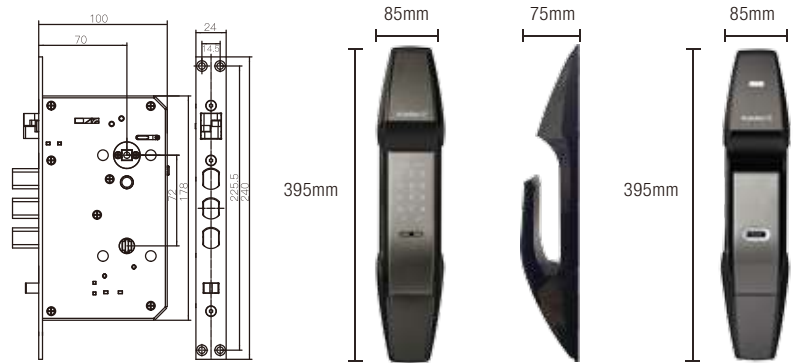

■ Product Dimension	: 395mm*85mm*75mm
■ Finishing	: Black
■ Material	: Zinc Alloy
	: Card Type: Mifare1, S50 Encrypted (Kaadas Exclusive)
	: Fingerprint Sensor: Semiconductor (Sweden FPC Fingerprint Sensor)
	: Keypad Type: Touchpad
■ Lock Type	: EN Stainless Steel Mortise Lock (Hole to Hole: 72mm, Backset: 70mm)
■ Cylinder Type	: Super Grade B
■ Authentication	: Pin Number: 6-12 digit
	: No of Master Pin code: 1 user only
	: No of Pin Code Registration: Up to 10 users
	: No of RFID Card Registration: Up to 100 users
	: No of Fingerprint Registration: Up to 100 users
	: No of Mechanical Key Combination: 2 keys
■ Installation	: Door Thickness: 35- 60mm (Default), 60-90mm (Optional)
	: Door Opening Direction: Universal Direction
	: Door Type: Wooden Door, Security Door & others
■ Power Supply	: Battery: AA Alkaline Battery
	: Battery Capacity: 4*AA Batteries
	: Working Voltage: DC 6V
	: Battery Life: 1 year* (*1 year: May be less depending on actual usage)
	: Emergency Power Supply: 5V Micro USB Power Bank
	: Low Battery Alert: YES

■ Included Accessories	No	Item Name	Quantity	Remark
		1	Outside Escutcheon with rubber gasket	1
	2	Inside Escutcheon with rubber gasket	1	
	3	EN Mortise	1	
	4	Screw Pack	1	
	5	User Manual	1	
	6	Warranty Card	1	
	7	Mechanical Keys	2	
	8	Strike Plate and Plastic Case	1	
	9	Installation Template	1	
	10	Inside Mounting Plate	1	
	11	RFID Card	2	
	12	Network Module	1	(Optional)

*Warranty: 2 years (*Must According to Kaadas's Terms & Conditions)















Kaadas

Access to your Future !

LEVER LOCK

S500



-  Bluetooth
-  100 Fingerprint User
-  100 Card User
-  10 Password User
-  Mechanical Key Provided
-  Anti Door Viewer Attack
-  Voice Guide (English & Chinese)
-  Emergency Power Supply (Micro USB)
-  High Security EN Mortise (3+1 Mortise Bolt)
-  Semi Locking Function
-  Double Authentication
-  Fake Pin Code
-  Anti Panic Function
-  Double Locking

Kaadas

Access to your Future !

LEVER LOCK

S500

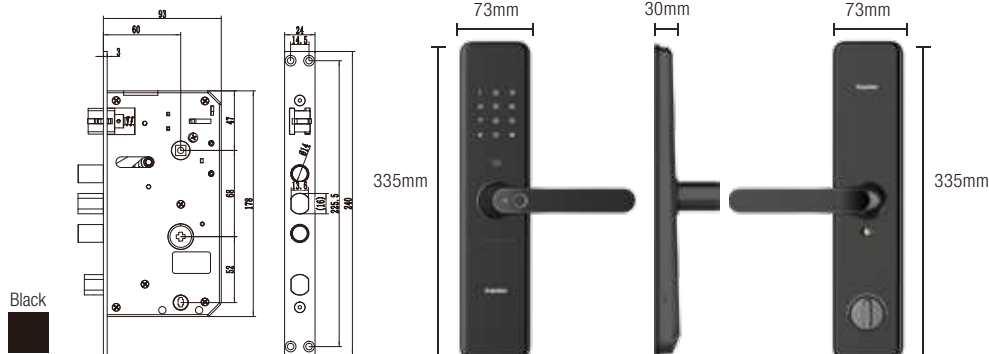

■ Product Dimension	: Front: 335mm*73mm*77mm : Back: 335mm*73mm*82mm
■ Finishing	: Black
■ Material	: Aluminium Alloy, Tempered Glass, ABS : Card Type: Mifare1, S50 Encrypted (Kaadas Exclusive) : Fingerprint Sensor: Semiconductor (Sweden FPC Fingerprint Sensor) : Keypad Type: 5A level temper glass keypad
■ Lock Type	: EN Stainless Steel Mortise Lock (Hole to Hole: 72mm, Backset: 60mm)
■ Cylinder Type	: Super Grade B
■ Authentication	: Pin Number: 6-12 digit : No of Master Pin Code: 1 user only : No of Pin Code Registration: Up to 10 users : No of RFID Card Registration: Up to 100 users : No of Fingerprint Registration: Up to 100 users : No of Mechanical Key Combination: 2 keys
■ Installation	: Door Thickness: 35- 60mm (Default) : Door Type: Wooden Door, Security Door & others
■ Power Supply	: Battery: AA Alkaline Battery : Battery Capacity: 4*AA Batteries or 8*AA Batteries : Working Voltage: DC 6V : Battery Life: 1 year* (*1 year: May be less depending on actual usage) : Emergency Power Supply: 5V Micro USB Power Bank : Low Battery Alert: YES

■ Included Accessories	No	Item Name	Quantity	Remark
	1	Outside Escutcheon with rubber gasket	1	
2	Inside Escutcheon with rubber gasket	1		
3	EN Mortise	1		
4	Mounting Accessory Kit	1		
5	User Manual	1		
6	Micro-Fiber Wiper	1		
7	Warranty Card	1		
8	Mechanical Keys	2		
9	Strike Plate Assembly	1		
10	Installation Template	1		
11	RFID Card	2		
12	Network Module	1	Optional	
13	Mounting Plate	1		

*Warranty: 2 years (*Must According to Kaadas's Terms & Conditions)















Kaadas

Access to your Future !

LEVER LOCK

L7



-  Bluetooth
-  100 Fingerprint User
-  100 Card User
-  10 Password User
-  Mechanical Key Provided
-  Anti-Door Viewer Attack
-  Voice Guide
(English, Spanish,
Portuguese, Chinese & French)
-  Emergency Power Supply
(Micro USB)
-  High Security EN Mortise
-  Auto Locking Function
-  Double Authentication
-  Fake Pin Code
-  Defense Mode
-  Anti Panic Function
-  Double Locking

Kaadas

Access to your Future !



LEVER LOCK



Black

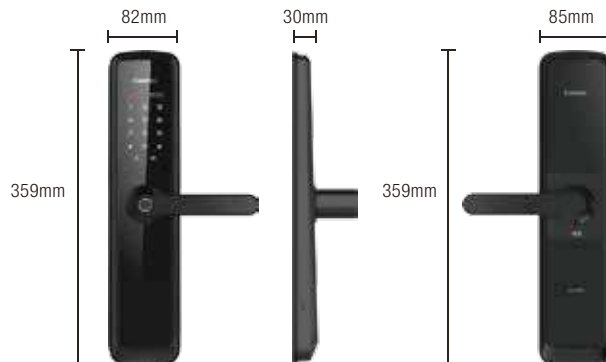
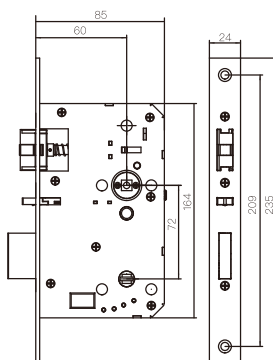

■ Product Dimension	: Front: 359mm*82mm*77mm : Back: 359mm*85mm*82mm
■ Finishing	: Black & Gold
■ Material	: Aluminium, Zinc Alloy, Tempered Glass, ABS : Card Type: Mifare1, S50 Encrypted (Kaadas Exclusive) : Fingerprint Sensor: Semiconductor (Sweden FPC Fingerprint Sensor) : Keypad Type: 5A level temper glass keypad
■ Lock Type	: EN Stainless Steel Mortise Lock (Hole to Hole: 72mm, Backset: 60mm & 70mm)
■ Cylinder Type	: Super Grade B
■ Authentication	: Pin Number: 6-12 digit : No of Master Pin Code: 1 user only : No of Pin Code Registration: Up to 10 users : No of RFID Card Registration: Up to 100 users : No of Fingerprint Registration: Up to 100 users : No of Mechanical Key Combination: 2 keys
■ Installation	: Door Thickness: 35- 60mm (Default) : Door Type: Wooden Door, Security Door & others
■ Power Supply	: Battery: AA Alkaline Battery : Battery Capacity: 4*AA Batteries or 8*AA Batteries : Working Voltage: DC 6V : Battery Life: 1 year* (*1 year: May be less depending on actual usage) : Emergency Power Supply: 5V Micro USB Power Bank : Low Battery Alert: YES

■ Included Accessories	No	Item Name	Quantity	Remark
	1	Outside Escutcheon with rubber gasket	1	
2	Inside Escutcheon with rubber gasket	1		
3	EN Mortise	1		
4	Mounting Accessory Kit	1		
5	User Manual	1		
6	Micro-Fiber Wiper	1		
7	Warranty Card	1		
8	Mechanical Keys	2		
9	Strike Plate Assembly	1		
10	Installation Template	1		
11	RFID Card	2		
12	Network Module	1	Optional	
13	Mounting Plate	1		

*Warranty: 2 years (*Must According to Kaadas's Terms & Conditions)









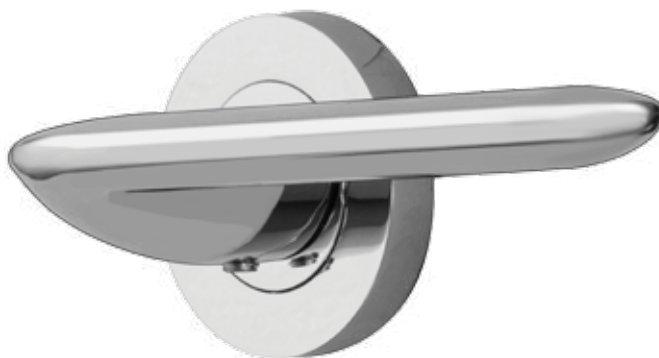





Kaadas

Access to your Future !

LEVER LOCK

M9



-  Bluetooth (Optional)
-  49 Fingerprint User
-  49 Card User
-  7 Password User
-  Mechanical Key Provided
-  Voice Guide (English & Chinese)
-  Emergency Power Supply (Micro USB)
-  High Security EN Mortise
-  Auto Locking Function
-  Double Authentication
-  Fake Pin Code
-  Defense Mode
-  Anti Panic Function
-  Double Locking

Kaadas

Access to your Future !



LEVER LOCK

M9

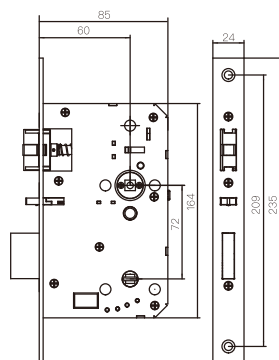

■ Product Dimension	: Front: 90mm*68mm*28mm : Back: 156mm*60mm*30mm
■ Finishing	: Polish Chrome
■ Material	: Zinc Alloy : Card Type: RFID, Mifare1, IC, S50, S70 : Fingerprint Sensor: Semiconductor (Sweden FPC Fingerprint Sensor) : Keypad Type: 5A level tempered glass
■ Lock Type	: EN Stainless Steel Mortise Lock (Hole to Hole: 72mm, Backset: 60mm)
■ Cylinder Type	: Super Grade B
■ Authentication	: Pin Number: 6-12 digit : No of Master Pin Code: 1 user only : No of Pin Code Registration: Up to 7 users : No of RFID Card Registration: Up to 49 users : No of Fingerprint Registration: Up to 49 users : No of Mechanical Key Combination: 2 keys
■ Installation	: Door Thickness: 35- 60mm (Default) : Door Type: Wooden Door
■ Power Supply	: Battery: AA Alkaline Battery : Battery Capacity: 4*AA Batteries : Working Voltage: DC 6V : Battery Life: 1 year* (*1 year: May be less depending on actual usage) : Emergency Power Supply: 5V Micro USB Power Bank : Low Battery Alert: YES

■ Included Accessories	No	Item Name	Quantity	Remark
	1	Outside Escutcheon	1	
2	Inside Escutcheon	1		
3	EN Mortise	1		
4	Screw Pack	1		
5	User Manual	1		
6	Warranty Card	1		
7	Mechanical Keys	2		
8	Strike Plate	1		
9	Installation Template	1		
10	RFID Card	2		
11	Network Module	1	Optional	

*Warranty: 2 years (*Must According to Kaadas's Terms & Conditions)











Kaadas

Access to your Future !

RIM LOCK

R6



-  Bluetooth
-  100 Fingerprint User
-  100 Card User
-  10 Password User
-  Mechanical Key Provided
-  Voice Guide (English, Spanish, Portuguese, Russian & Chinese)
-  Emergency Power Supply (Micro USB)
-  Sound Volume Adjustable
-  Auto Locking Function
-  Fake Pin Code
-  Double Authentication



Kaadas

Access to your Future !



RIM LOCK

R6

Black



■ Product Dimension	: Front: 172mm*71mm*13mm : Back: 200mm*77mm*48mm
■ Finishing	: Bright Chrome
■ Material	: Zinc Alloy : Card Type: RFID, Mifare, IC, S50, S70 : Keypad Type: Touchpad
■ Lock Type	: RIM Lock Type (Backset:45- 50mm)
■ Authentication	: Pin Number: 4-10 digit : No of Master Pin Code: 1 user only : No of Pin Code Registration: Up to 20 users : No of RFID Card Registration: Up to 100 users
■ Installation	: Door Thickness: 30- 50mm (Default) : Door Type: Wooden Door
■ Power Supply	: Battery: AA Alkaline Battery : Battery Capacity: 4*AA Batteries : Working Voltage: DC 6V : Battery Life: 1 year* (*1 year: May be less depending on actual usage) : Emergency Power Supply: 5V Micro USB Power Bank : Low Battery Alert: YES

■ Product Dimension	: Front: 172mm*71mm*13mm : Back: 200mm*77mm*48mm
■ Finishing	: Matte Black
■ Material	: Aluminium Alloy : Card Type: RFID, Mifare, IC, S50, S70 : Fingerprint Sensor: Semiconductor (Sweden FPC Fingerprint Sensor) : Keypad Type: Touchpad
■ Lock Type	: RIM Lock Type (Backset:45-50mm)
■ Authentication	: Pin Number: 6-12 digit : No of Master Pin Code: 1 user only : No of Pin Code Registration: Up to 10 users : No of RFID Card Registration: Up to 100 users : No of Fingerprint registration: Up to 100 users
■ Installation	: Door Thickness: 30- 50mm (Default) : Door Type: Wooden Door
■ Power Supply	: Battery: AA Alkaline Battery : Battery Capacity: 4*AA Batteries : Working Voltage: DC 6V : Battery Life: 1 year* (*1 year: May be less depending on actual usage) : Emergency Power Supply: 5V Micro USB Power Bank : Low Battery Alert: YES

*Warranty: 2 years (*Must According to Kaadas's Terms & Conditions)

R7-2

R6-5













Kaadas

Access to your Future !

GRILL RIM LOCK

R6



-  Bluetooth
-  100 Fingerprint User
-  100 Card User
-  10 Password User
-  1 Remote Control
-  Mechanical Key Provided
-  Voice Guide (English, Spanish, Portuguese, Russian & Chinese)
-  Emergency Power Supply (Micro USB)
-  Sound Volume Adjustable
-  Auto Locking Function
-  Fake Pin Code
-  Double Authentication



Kaadas

Access to your Future !

GRILL RIM LOCK

R6



■ Product Dimension	: Front: 172mm*71mm*13mm : Back: 200mm*77mm*48mm
■ Finishing	: Matte Black
■ Material	: Aluminium Alloy : Card Type: RFID, Mifare, IC, S50, S70 : Fingerprint Sensor: Semiconductor (Sweden FPC Fingerprint Sensor) : Keypad Type: Touchpad : Cylinder: High Security Special Key : Remote Control: 1 Set
■ Lock Type	: RIM Lock Type (Backset:45- 50mm)
■ Authentication	: Pin Number: 6-12 digit : No of Master Pin Code: 1 user only : No of Pin Code Registration: Up to 10 users : No of RFID Card Registration: Up to 100 users : No of Fingerprint registration: Up to 100 users
■ Installation	: Door Thickness: 30- 50mm (Default) : Door Type: Grill Door
■ Power Supply	: Battery: AA Alkaline Battery : Battery Capacity: 4*AA Batteries : Working Voltage: DC 6V : Battery Life: 1 year* (*1 year: May be less depending on actual usage) : Emergency Power Supply: 5V Micro USB Power Bank : Low Battery Alert: YES

PADLOCK

M100



Silver Red

- Features
 1. Compact and Portable
 2. Strong Anti-Collision
 3. Accurate Fingerprint Unlocking
 4. 20 Large Fingerprint Capacity
 5. Up to 2000 times Unlocking in Full Power

- Product Specification
 1. Main Material: Zinc Alloy (Body) & Stainless Steel (Shackle)
 2. Fingerprint Sensor: Semiconductor
 3. Fingerprint Quantity: 20 Fingerprint (2 Master Fingerprints, 18 User Fingerprints)
 4. Response Speed: 0.2 seconds
 5. Battery: Lithium Battery
 6. Charger: 5V Micro USB

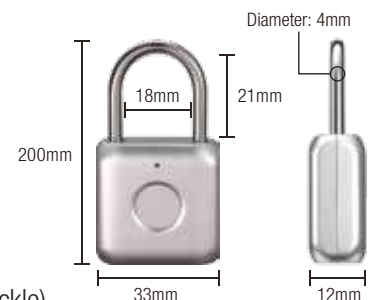

*Warranty: 2 years (*Must According to Kaadas's Terms & Conditions)

R6-5K

M100