

HR2 - HR4 HANDRAIL SYSTEM

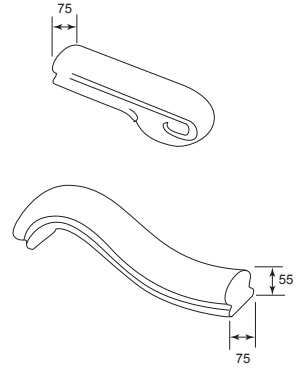

End Rail 3" x 2¼" **U/Price: 274.00**



S-Rail 3" x 2¼" **U/Price: 346.00**



C-Rail (Up) 3" x 2¼"

U/Price: 346.00

C-Rail (Down) 3" x 2¼"

U/Price: 346.00

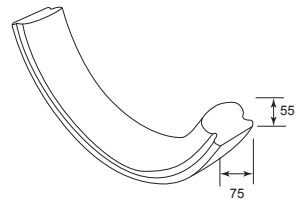

U-Rail 3" x 2¼"

U/Price: 343.00

L-Rail 3" x 2¼"

U/Price: 306.00

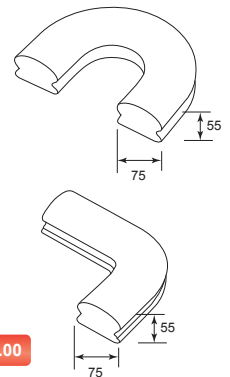

HANDRAIL SYSTEM



End Curve Rail-1 (right)
3" x 2¼"

U/Price: 727.00



End Curve Rail-1 (left)
3" x 2¼"

U/Price: 727.00

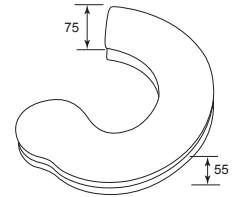

End Curve Rail-2 (right)
3" x 2¼"

U/Price: 319.00



End Curve Rail-2 (left)
3" x 2¼"

U/Price: 319.00

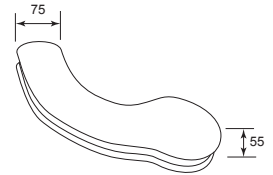

Handrail
HR 1720

U/Price: 33.00

Per Ft Run

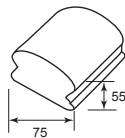

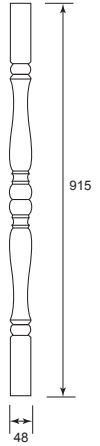
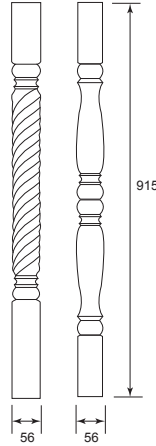
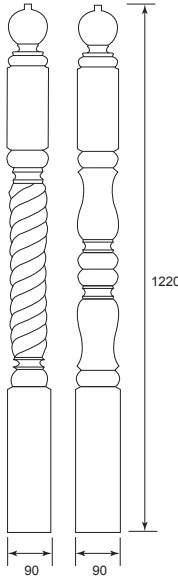

Twist Newel Post
4" x 4" x 48"

Newel Post
4" x 4" x 48"

U/Price: 290.00

U/Price: 212.00



Twist Baluster Post
2½" x 2½" x 36"

Baluster Post
2½" x 2½" x 36"

Baluster Post
2" x 2" x 36"

U/Price: 127.00

U/Price: 65.00

U/Price: 40.00